

High Voltage, High Frequency Switching Using a Cascode Connection of HEXFET® and Bipolar Transistor

(HEXFET is the trademark for International Rectifier Power MOSFETs)

By S. CLEMENTE, B. PELLY, R. RUTTONSHA, B. TAYLOR

Summary

A cascode connection of high voltage bipolar transistor and low voltage HEXFET is described. A specific example is considered that is capable of switching 10A at 750V in 200-300 nanoseconds. The use of this combination "BIMOS" switch is demonstrated in a 10A inverter bridge circuit operating at 25kHz from a dc input voltage up to 750V.

Introduction

Power HEXFETs are now firmly established at voltage ratings up to 500V. Their main attributes are very fast switching speed, permitting switching frequencies of hundreds of kilohertz — very high input impedance, permitting very simple drive circuitry — and absence of second breakdown, permitting reduction or elimination of protection circuitry, and enhanced reliability.

The power HEXFET is a majority carrier device, and its on-state voltage drop is a strong function of voltage rating. A 100V rated HEXFET, for example, has a voltage drop at rated usable current, at rated maximum junction temperature, of about 2.5V, while a 500V rated device has a voltage drop of about 9V, at rated maximum junction temperature.

MOSFETs with voltage ratings above 500V are technically feasible, but voltage drop increases rapidly, as illustrated in Figure 1. An 850V rated MOSFET, for example, would have a voltage drop of about 18V, and a 1000V rated MOSFET would have about a 23V drop. This relationship between voltage drop and voltage rating is presently a barrier to general commercial usage of power MOSFETs at voltage ratings much above 500V.

Circuit designers would nonetheless welcome an 800 to 1000V rated device, with the switching performance and Safe Operating Area of a power HEXFET, but with a voltage drop — and price — that are lower than those of a comparably rated high voltage MOSFET.

This device, if it existed, would open up a range of application possibilities, such as direct off-line (240V) high frequency (20-250kHz) single-ended switching power supplies, and direct off-line (440/480V, 3-phase) high frequency bridge inverter circuits for motor drives, uninterruptible power supplies, and high power (class D) switching amplifiers.

The concept of using a low voltage, fast switching transistor in the emitter of a second high voltage transistor —

in a so-called *cascode* connection — to yield a combined high voltage, high speed switch is not new, and has been employed in the past using pairs of bipolar transistors.

With the availability of power HEXFETs, this cascode technique can be looked at with renewed interest, because a high voltage device with HEXFET-like switching performance and relatively low conduction voltage drop can be implemented by combining a high voltage bipolar with a low voltage HEXFET. The best features of each device can be combined to provide operating characteristics that cannot be achieved with either one on its own. This cascode combination of *Bipolar* transistor and power *MOSFET* is referred to in this application note as a *BIMOS* switch.

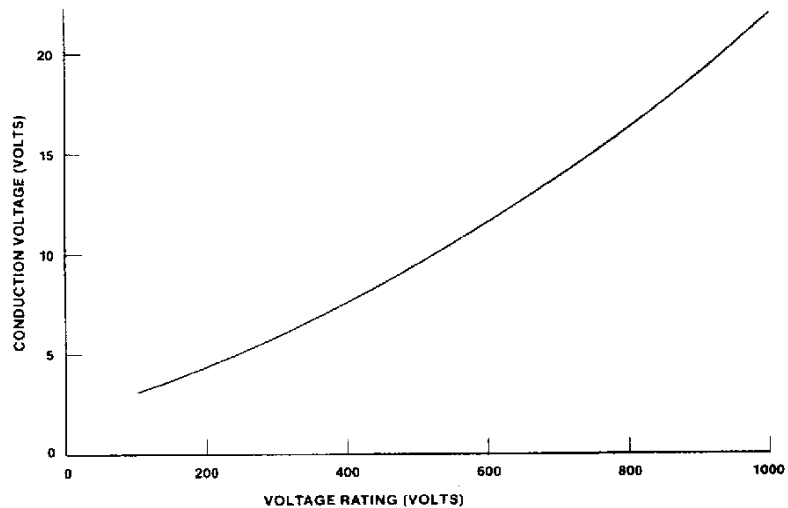

Figure 1. Conduction voltage versus voltage rating of power MOSFET. $T_J = 150^\circ\text{C}$

Basic Principle of BIMOS Switch

The basic BIMOS switch is shown in Figure 2. It is switched ON and OFF by control of the gate of the HEXFET. When the HEXFET is ON, the bipolar is ON, since it receives base drive current from the bias supply voltage V_B . When the HEXFET is OFF, the bipolar is also OFF, since its emitter is open-circuited.

The voltage developed across the HEXFET when it is OFF is essentially only the bias voltage supply V_B (typically 10 to 15V). The collector-source blocking voltage capability of the combined BIMOS switch is the relatively high V_{CBO} rating of the bipolar, because of the "common base" configuration. In addition, the switching speed of the bipolar is much faster than is achievable in the usual common emitter connection. In essence, this is because the "forcible" opening of the emitter at switch-OFF diverts the collector current in its entirety out of the base.

Since the ON or OFF condition of the BIMOS switch is controlled at the gate of the HEXFET, the input impedance is that of the HEXFET; the externally applied drive current is only that needed to charge and discharge the self capacitance of the HEXFET.

Consideration of a specific example — the 2N6547 bipolar transistor in combination with the IRFZ24 HEXFET — will illustrate typical performance characteristics. Figure 3 shows the Switching Safe Operating Area of the 2N6547 transistor in common base configuration. Also shown is the Safe Operating Area for the common emitter configuration. Note the substantially wider Safe Operating Area for common base, reflecting the 850V V_{CBO} rating versus the 400V V_{CEO} rating of this device.

Table 1 shows typical switching times of the 2N6547 in the common base connection, for different conduction times, when switching 10A in a 650V circuit. The storage times (180ns to 1000ns) are considerably shorter than for the common emitter connection (typically 2 to 4 μ s), as are the switching times (40ns to 230ns versus 1 to 1.5 μ s).

Table 1. Turn-Off Switching Times — 2N6547 (Common Base). Clamped Inductive Load.

On Time	Storage Time	Switching Time
1 μ s	180ns	40ns
2 μ s	200ns	50ns
4 μ s	400ns	85ns
6 μ s	520ns	120ns
8 μ s	620ns	160ns
10 μ s	700ns	170ns
15 μ s	900ns	210ns
20 μ s	1000ns	230ns

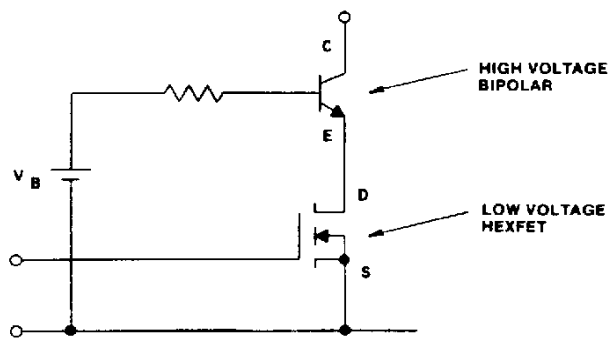

Figure 2. Cascode connection of HEXFET and bipolar

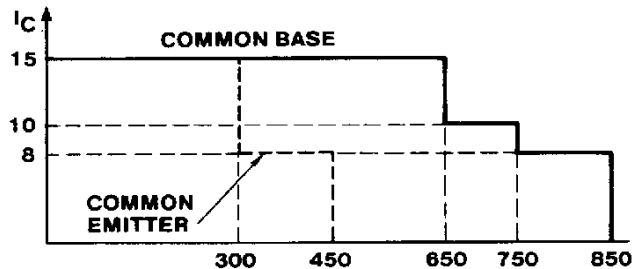

Figure 3. Comparison of common emitter and common base switching SOA of 2N6547 Bipolar

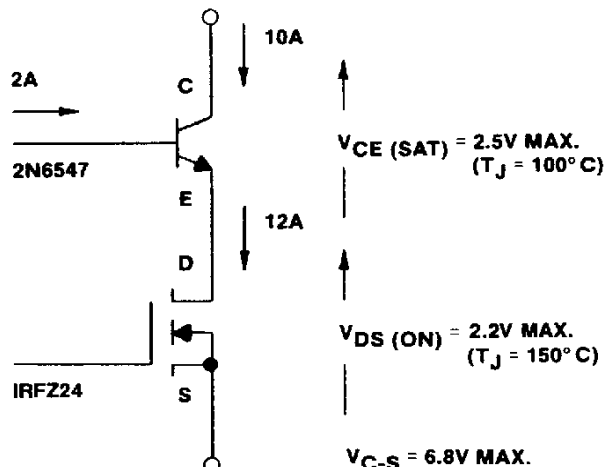

Figure 4. Maximum conduction voltage of BIMOS switch using 2N6547 and IRFZ24

Test Conditions

for Table 1 are: $I_C = 10$ Amps
 $I_B = 2$ Amps
 $V_{\text{collector}} = 650$ V DC

Switching time is the sum of collector voltage rise time and collector current fall time, measured from 10% collector voltage to 10% collector current.

As illustrated in Figure 4, the conduction voltage drop across the BIMOS switch at a load current of 10A (the maximum usable current of the 2N6547) is about 6.8V. This compares with about 18V for an equivalent 10A, 850V rated HEXFET.

Circuit Implementation

In practice it will generally be more convenient to replace the fixed voltage supply V_B in Figure 2 with a proportional base drive, derived from a current transformer in the collector circuit. A practical circuit is shown in Figure 5.

The capacitor C1 is charged to the voltage of the zener diode DZ1 when the BIMOS switch is OFF. When the HEXFET is switched ON, base drive for the bipolar is initially derived from C1. Once the collector current is estab-

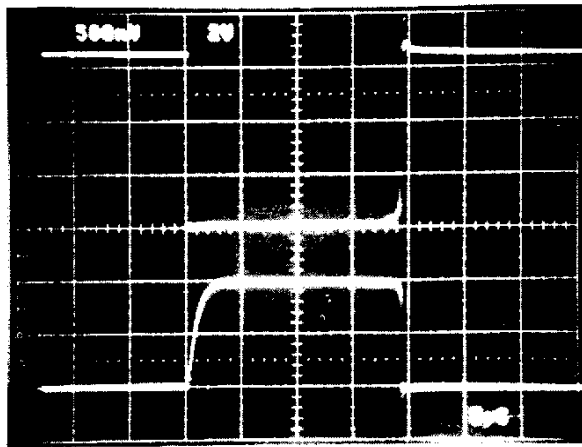

(a) Upper: 200V/div 5μs/div
Lower: 5A/div

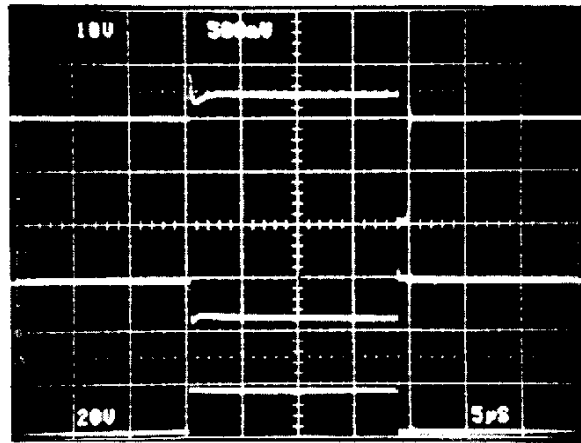

(b) Upper: 5A/div 5μs/div
Middle: 10V/div Lower: 20V/div

Figure 6. Oscillograms for BIMOS switch of Figure 5 when switching 650V, 10A into resistive/inductive load (65Ω, 50μH) with parallel clamping diode

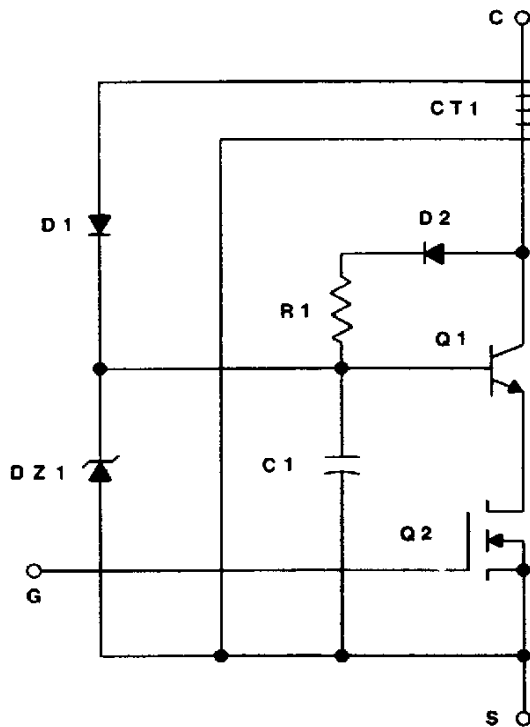

Figure 5. Practical implementation of BIMOS switch
(For component detail see Table 2, page 6.)

lished, CT1 supplies steady base drive current to the bipolar.

With this particular transformer the maximum ON time of the switch when carrying 10A is about 25μs, and the minimum OFF time — required to reset the current transformer — is about 1.5μs. The peak “reset” voltage across the secondary of the current transformer is approximately 135V; this is determined largely by circuit capacitance. Typical operating oscillograms for this basic BIMOS switch are shown in Figures 6 through 10. A brief description of these waveforms follows:

Figure 6(a) shows waveforms of voltage and current when switching 650V, 10A. The load has approximately 65Ω resistance and 50μH series inductance, with a clamping (free-wheeling) diode connected across it. The relatively slow rate of rise of current at switch ON is due to the load inductance. Note the rapid fall time of the voltage during turn ON and the rapid rise and fall times of the voltage and current during turn OFF.

Figure 6(b) shows the base current in the bipolar transistor, the voltage across DZ1, and the drive voltage at the gate of the HEXFET. Note the initial “spike” of base current supplied by the capacitor C1. Note also the reverse base current of 10A during the storage period, equal to the 10A collector current, due to the open emitter. The storage time for this 10A collector

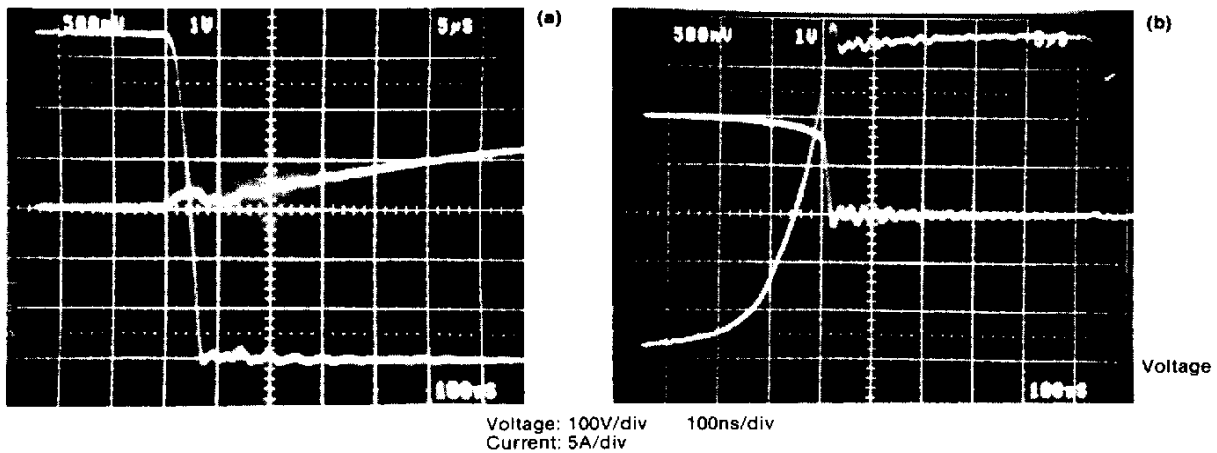

Figure 7. Voltage and current waveforms for BIMOS switch of Figure 5 (a) at turn-ON, and (b) at turn-OFF, when switching 650V, 10A, into resistive/inductive load (65Ω, 50μH) with parallel clamping diode

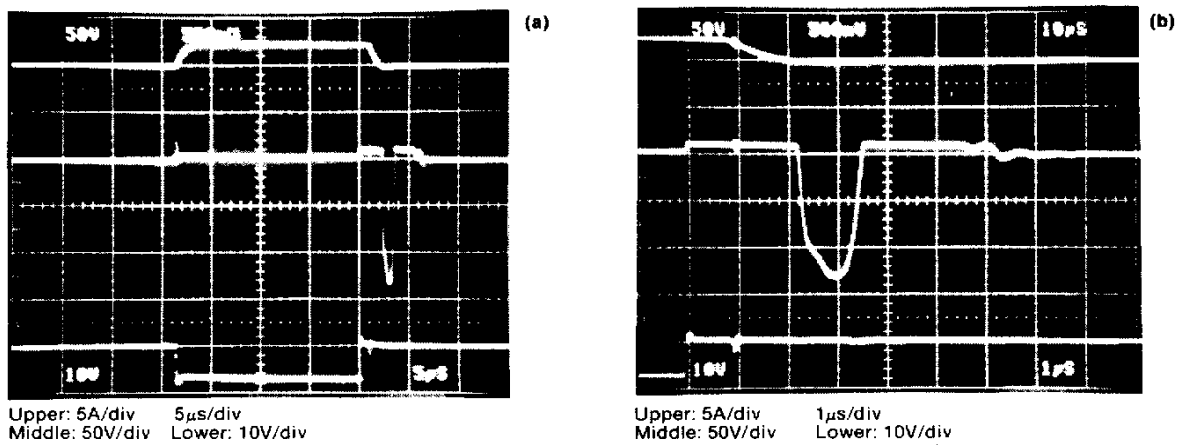

Figure 8. Base drive circuit waveforms for BIMOS switch of Figure 5 when switching 10A (a) 5μs/div (b) expanded to 1μs/div to show details of turn-OFF

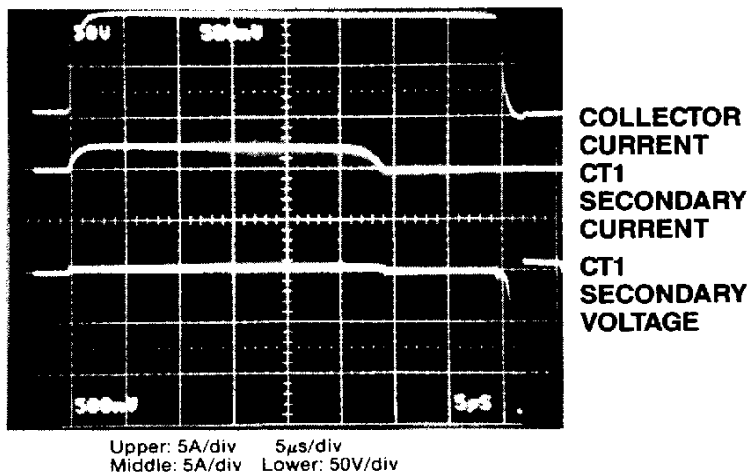

Figure 9. Base drive circuit waveforms for BIMOS switch of Figure 5 with conduction time greater than the 25μs maximum limit permitted by CT1

current level and 18μs conduction time is approximately 1μs.

Figure 7 shows expanded voltage and current waveforms for the BIMOS switch at turn-ON and turn-OFF. The voltage fall time at turn-ON is less than 100ns, and the combined voltage rise time and current fall time at turn-OFF for this 18μs conduction time is about 200 nanoseconds.

Figure 8 shows base drive waveforms for the bipolar. The reset voltage spike across the secondary of CT1 has a peak value of approximately 135V. The reset time is approximately 1.5μs.

Figure 9 shows base drive waveforms for a "forbidden" operating mode when the conduction time is extended beyond the 25μs maximum permitted by this particular current transformer. The transformer starts to saturate after about 28μs, collapsing the base drive to the transistor. Since

the HEXFET is still switched ON, the emitter of the bipolar is still "grounded." The collector current continues to flow for the relatively long "grounded emitter" storage time of the bipolar — about 12 μ s. (To add insult to injury, negative base current is zero; this would normally be applied to the grounded emitter configuration to shorten storage time.) The "grounded base" storage time, by contrast, (Figure 6(b)) is about 1 μ s.

Figure 10 shows the effect on the switching waveforms of changing the

voltage of zener diode DZ1 (Figure 5). With a zener voltage of 5V (Figure 10(a)), the fall time of the voltage at turn-ON is relatively slow (100ns), since the capacitor C1 is charged to only 5V, and supplies only a mediocre "spike" of base current at turn-ON. During the storage time at turn-OFF the collector-drain voltage becomes the zener voltage of DZ1 plus the collector-base voltage; this voltage is relatively low, because the zener voltage is relatively low. Dissipation during this period is therefore relatively small.

With a zener voltage of 18V (Figure

10(b)) the fall time of the voltage at turn-ON is reduced to about 50ns, because of the increased charge in C1. The collector-drain voltage at turn-OFF during the storage time is, however, relatively high, because the zener voltage is relatively high, and dissipation during this period is increased.

Judicious selection of the zener voltage will minimize the total switching losses. The 10V zener used in Figure 5 and 11 was judged to be near-optimum.

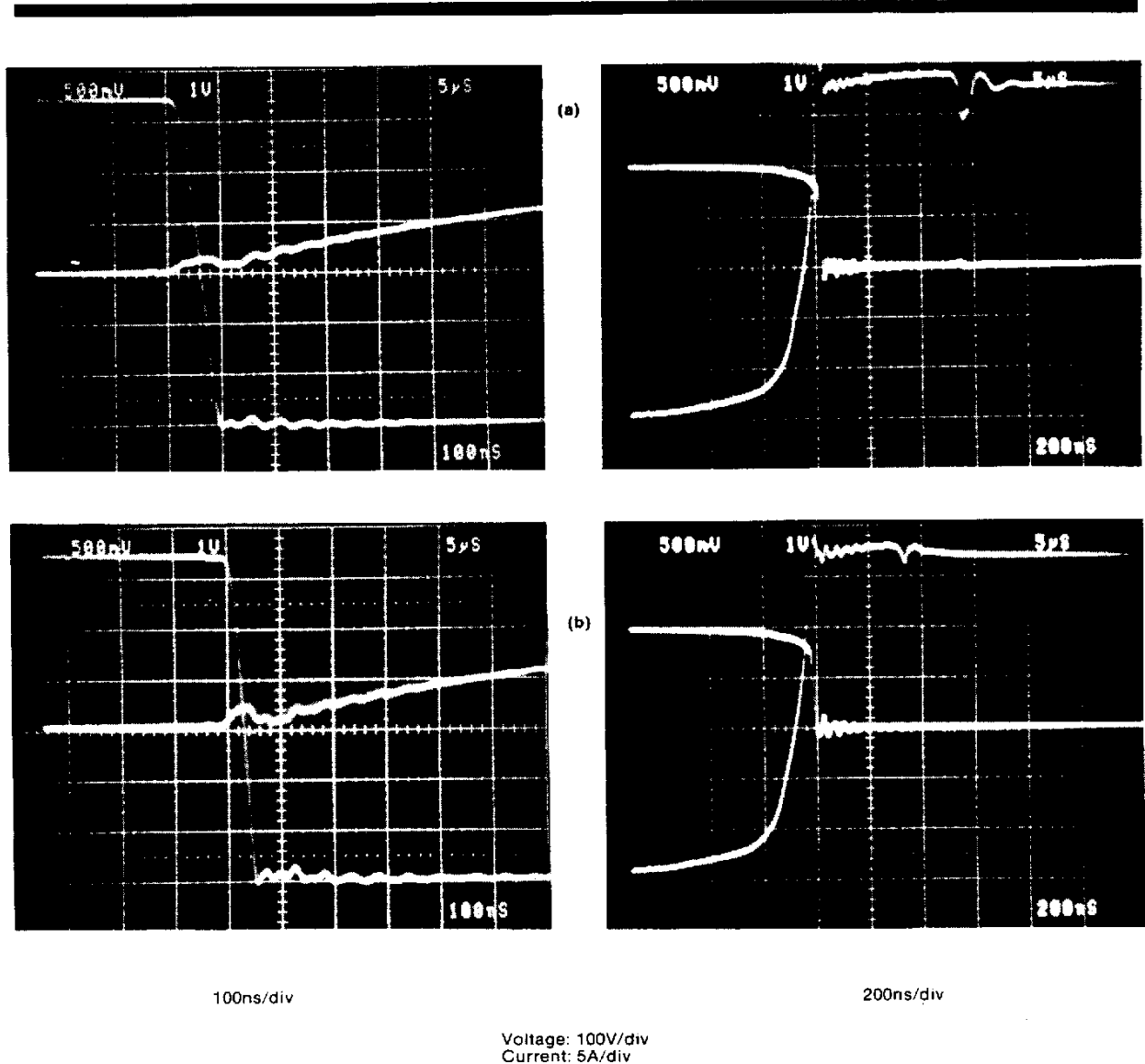

Figure 10. Voltage and current waveforms at turn-ON and turn-OFF for the BIMOS switch of Figure 5 when switching 10A at 650V with DZ1 voltage (a) 5V and (b) 18V

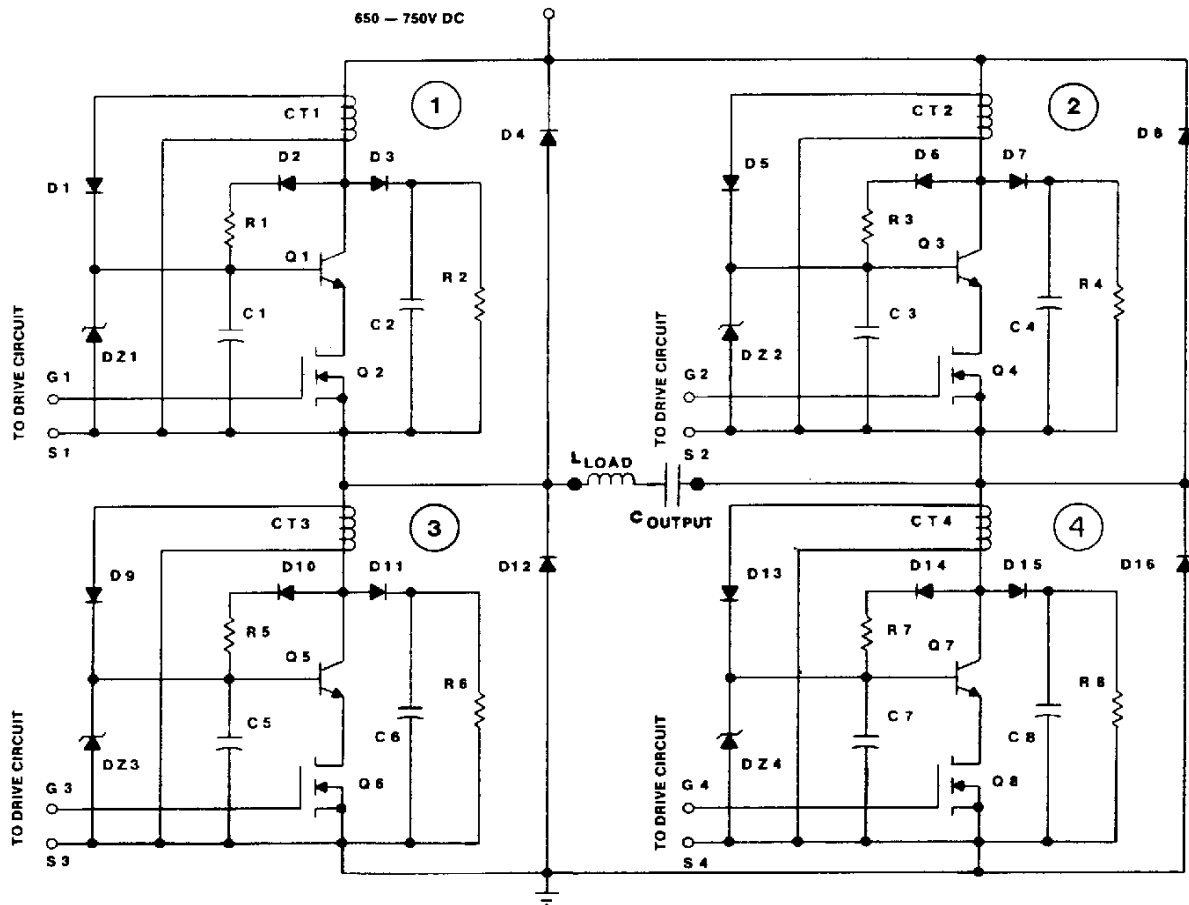

Figure 11. BIMOS bridge circuit

Table 2. Components Listing for Figure 5 and 11.

LIST OF COMPONENTS FOR BIMOS BRIDGE CIRCUIT	
Q ₁ , Q ₃ , Q ₅ , Q ₇	IR2N6547
Q ₂ , Q ₄ , Q ₆ , Q ₈	IRFZ24
C ₁ , C ₃ , C ₅ , C ₇	0.1μF
C ₂ , C ₄ , C ₆ , C ₈	0.068μF, 1000V
R ₁ , R ₃ , R ₅ , R ₇	100k ½W
R ₂ , R ₄ , R ₆ , R ₈	100k 2W
D ₁ , D ₅ , D ₉ , D ₁₃	UES1305
D ₂ , D ₆ , D ₁₀ , D ₁₄	IR IN4007
D ₃ , D ₇ , D ₁₁ , D ₁₅	Two IR 40SL6 connected in series with sharing resistors
D ₄ , D ₈ , D ₁₂ , D ₁₆	12FL100S05
DZ, DZ ₂ , DZ ₃ , DZ ₄	10V zener diode, 1.5W
CT ₁ , CT ₂ , CT ₃ , CT ₄	Primary 2 turns #16 Secondary 10 turns #24 Core TDK H5B2T10-20-5

A BIMOS Bridge Inverter Operating at 650-750V DC, 10A, 25kHz

A major circuit application area for a BIMOS switch is in high frequency bridge inverters operating from 440/480V, 1 or 3-phase lines, for large switching power supplies, motor drives, welding, induction heating, uninterruptible power supplies, high power switching amplifiers, and so on.

The feasibility of a BIMOS switch for this type of application has been demonstrated in an experimental single phase BIMOS bridge circuit operating from 650 to 750V DC at 10A, 25kHz. A diagram of the power circuit is shown in Figure 11. The test results reported in this article are for an inductive load, with a blocking capacitor, C_{OUTPUT}, used to prevent DC load saturation. The experimental control and drive circuitry is shown in Figure 12.

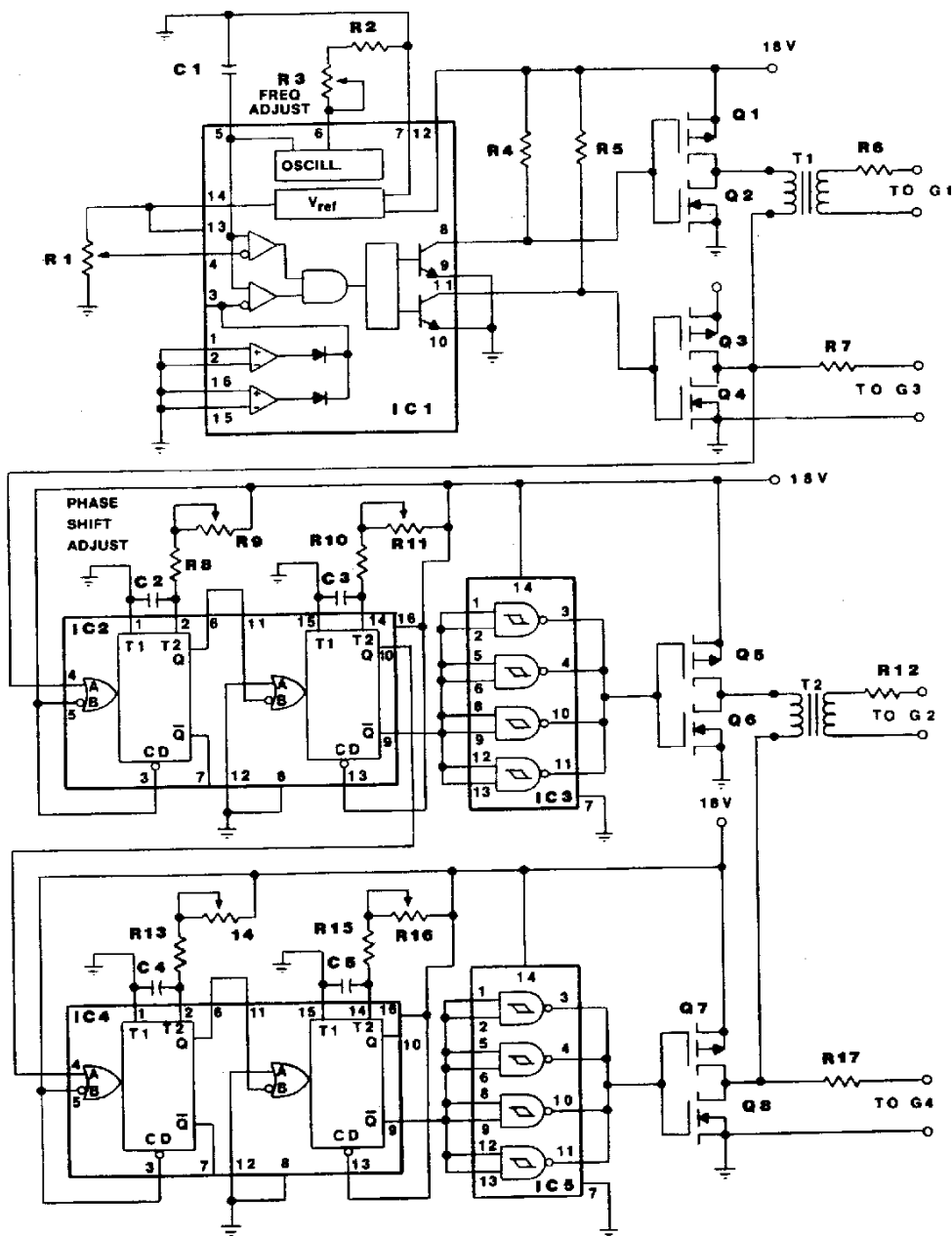

Figure 12. Control and drive circuit for BIMOS bridge

Table 3. Components Listing for Figure 12.

LIST OF COMPONENTS FOR CONTROL AND DRIVE CIRCUIT FOR BIMOS BRIDGE			
Q ₁ , Q ₃ , Q ₅ , Q ₇	IRFD9014	R ₃	5kΩ, ten turn potentiometer ¼W
Q ₂ , Q ₄ , Q ₆ , Q ₈	IRFD014	R ₄ , R ₅	150Ω, 2W
IC ₁	Texas Instrument TL494	R ₆ , R ₇ , R ₁₂ , R ₁₇	22Ω, ¼W
IC ₂ , IC ₄	MC14528B	R ₈ , R ₁₀ , R ₁₃ , R ₁₅	4.7kΩ, ¼W
IC ₃ , IC ₅	MC14093B	R ₉	500kΩ, ¼W ten turn potentiometer
C ₁	0.01μF	R ₁₁ , R ₁₄ , R ₁₆	50kΩ, ¼W ten turn potentiometer
C ₂	68pF	T ₁ , T ₂	Primary: 40 turns #24 Secondary: 40 turns #24 Core TDK H ₅ B ₂ T10-20-5
C ₃ , C ₄ , C ₅	.0068μF		
R ₁	5kΩ, ten turn potentiometer		
R ₂	2.2K ¼W		

Idealized gating waveforms for the BIMOS switches are shown in Figure 13. Each leg or "pole" of the inverter circuit is gated to deliver a 180° square wave of output voltage (with respect to DC midpoint potential), with a short deadtime when switching from an upper to a lower device, and vice versa, to allow for the storage time of the BIMOS switch. Pulse width control of the output voltage of the bridge is obtained by phase-shifting the gating waveforms applied to the two legs of the bridge. With this gating regime two of the four switches are always gated ON (except during the short crossover dead-time), and the output voltage waveform is always defined by

the gating pattern, independent of the load characteristics.

A "simpler" gating regime under which diagonally opposite pairs of switches were simultaneously gated ON for a controllable time, with all gating signals being removed during the intervening periods, was unsatisfactory. This is because substantial oscillation took place between the self capacitance of the switch and the inductance of the load, once inductive current feedback from the load to the DC source was completed, and the BIMOS switches were then left temporarily "floating" with no gating signals applied to them. Operation with

this "incorrect" gating regime is illustrated by the oscillograms in Figure 14.

Figures 15 through 24 show waveforms which illustrate the operation of this experimental BIMOS bridge circuit. The dc input voltage for Figures 15 through 23 is 650V, and for Figure 24 it is 750V. A description of these oscillograms follows:

Figure 15(a) shows output voltage and current waveforms with partial-width output voltage pulses, and Figure 15(b) shows corresponding waveforms with almost "full" width output voltage. The peak current for this latter case is approximately 10A.

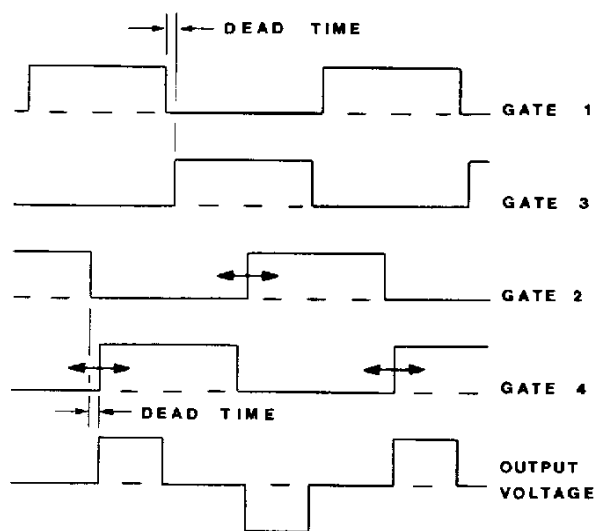

Figure 13. Gating regime for experimental BIMOS bridge

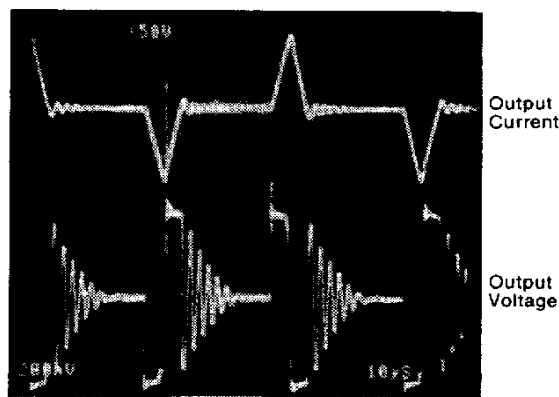
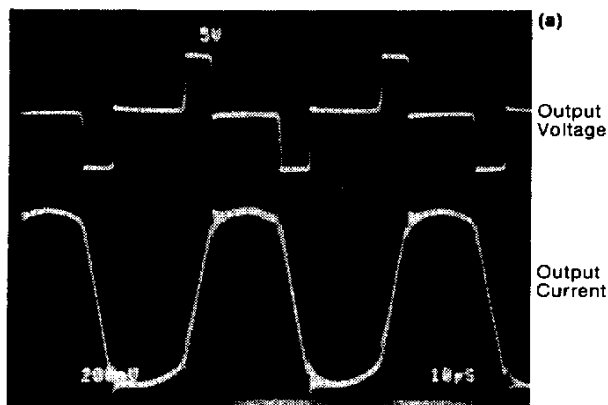
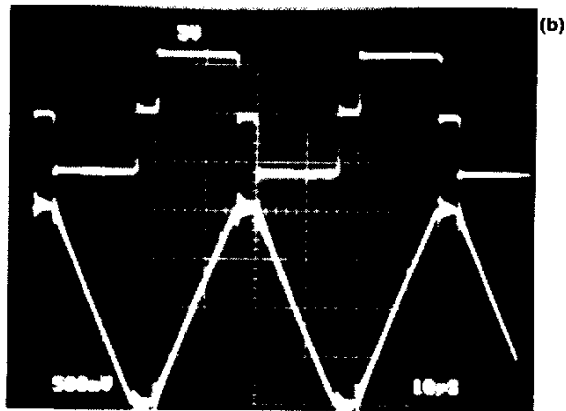

Figure 14. Output current and voltage waveforms with "incorrect" gating regime. Inductive load



Upper: 500V/div 10µs/div
Lower: 2A/div



Upper: 500V/div 10µs/div
Lower: 5A/div

Figure 15. Output voltage and current of BIMOS bridge circuit with 650V DC input
(a) "Partial" output voltage
(b) "Full" output voltage

Figures 16(a) and (b) show the output voltage and gating pulses for BIMOS switches No's 3 and 4 at partial and full output voltage respectively.

Figure 17 shows voltage and current waveforms for the No. 1 BIMOS

switch/feedback diode combination, at partial and full output voltage. Note the relatively long period of "negative" freewheeling current in the feedback diode at partial output because of the relatively short period of the "active" output voltage pulse.

Figure 18 shows an expanded trace of voltage and current for the No. 1 BIMOS switch/feedback diode combination, during the time that the No. 3 switch turns off, forcing inductive load current into the No. 1 feedback diode.

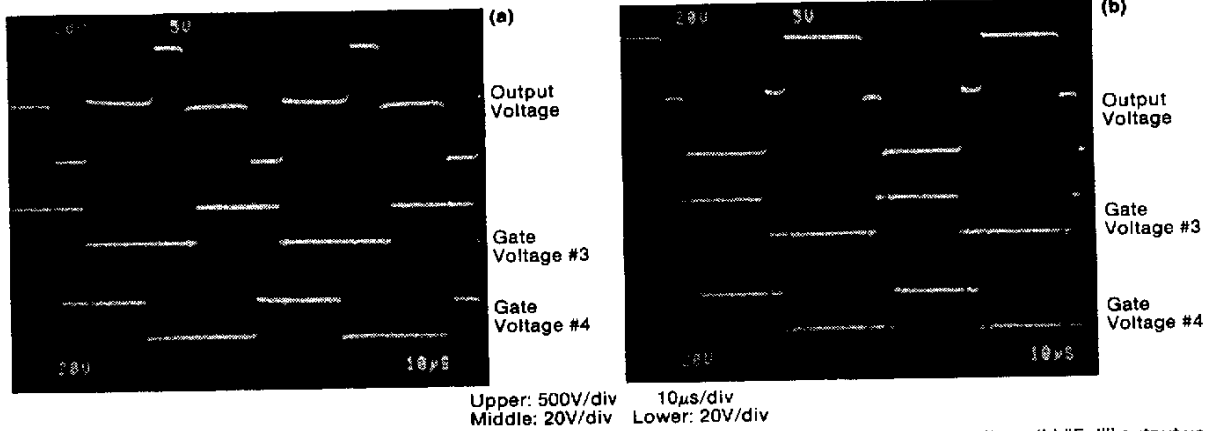

Figure 16. Output voltage and gate drive voltages for BIMOS bridge. 650V DC input. (a) "Partial" output voltage (b) "Full" output voltage

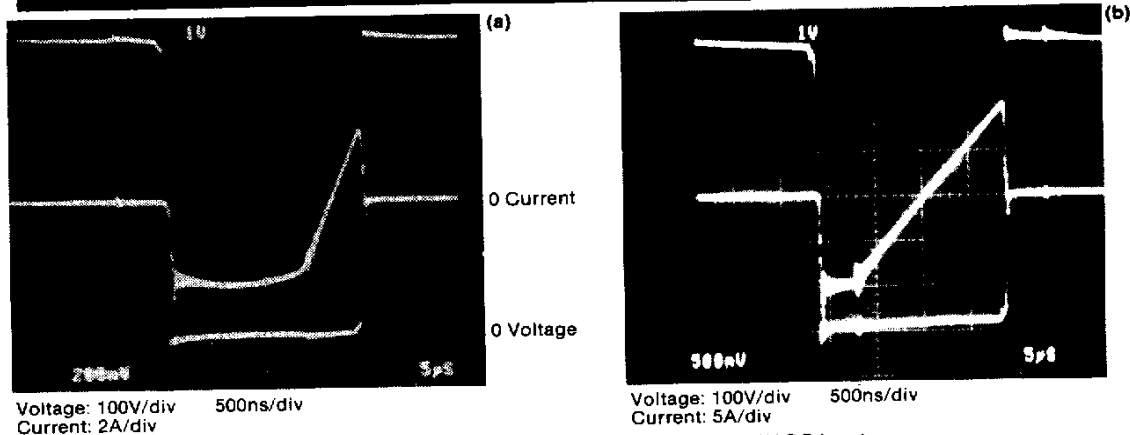

Figure 17. Voltage and current for BIMOS switch/feedback diode combination. 650V DC input. (a) "Partial" output voltage (3A peak at switch-off) (b) "Full" output voltage (10A peak at switch-off)

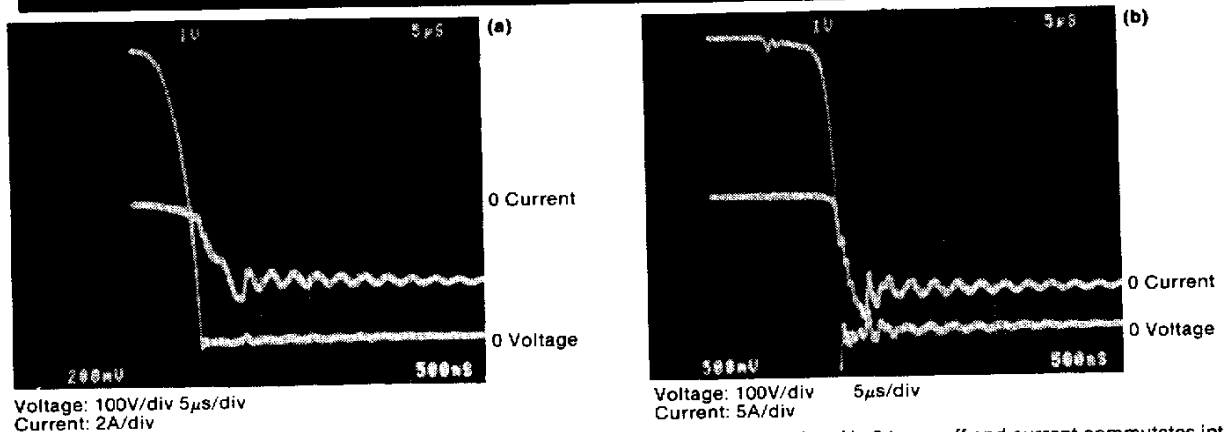

Figure 18. Voltage and current for No. 1 BIMOS switch/feedback diode combination when No.3 turns-off and current commutates into No. 1 feedback diode. 650V DC input. (a) "Partial" output voltage (3.5A peak at commutation) (b) "Full" output voltage (10A peak at commutation)

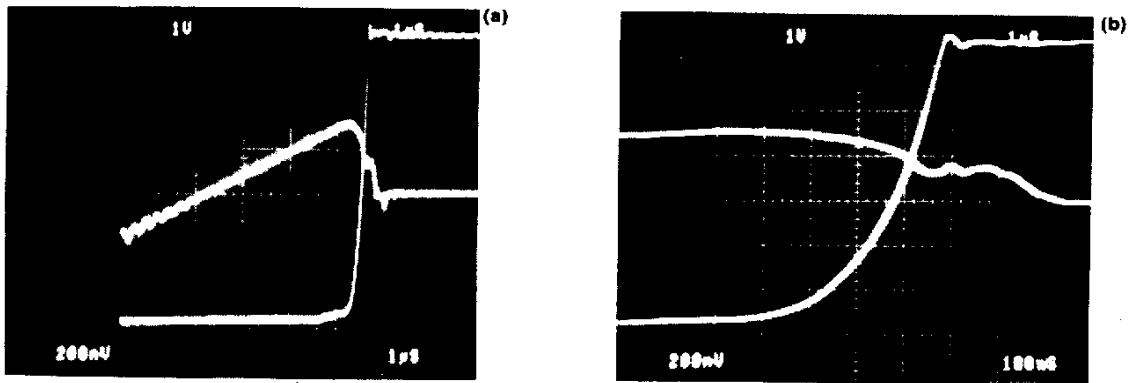

Figure 19. Voltage and current for BIMOS switch at partial output voltage when switching off 3A. (a) 1 μ s/div (b) 100ns/div 650V DC input.

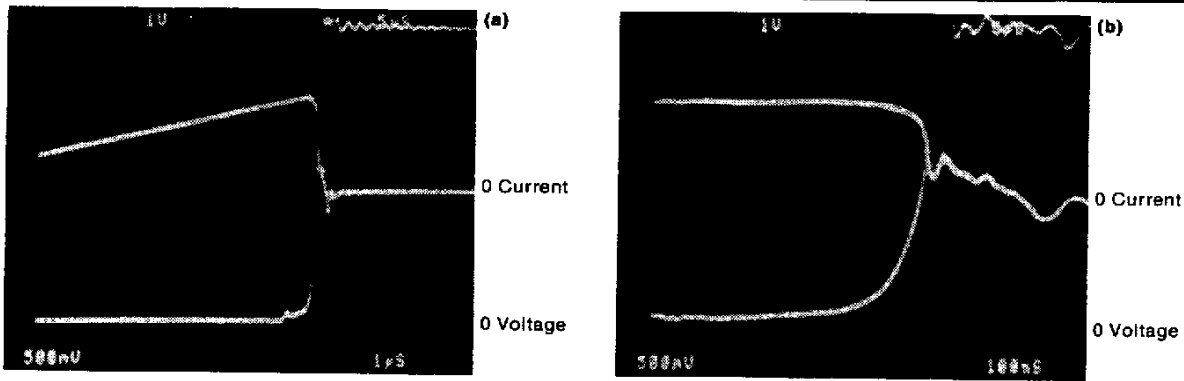

Figure 20. Voltage and current for BIMOS switch at full output voltage when switching off 10A. (a) 1 μ s/div (b) 100 μ s/div 650V DC input.

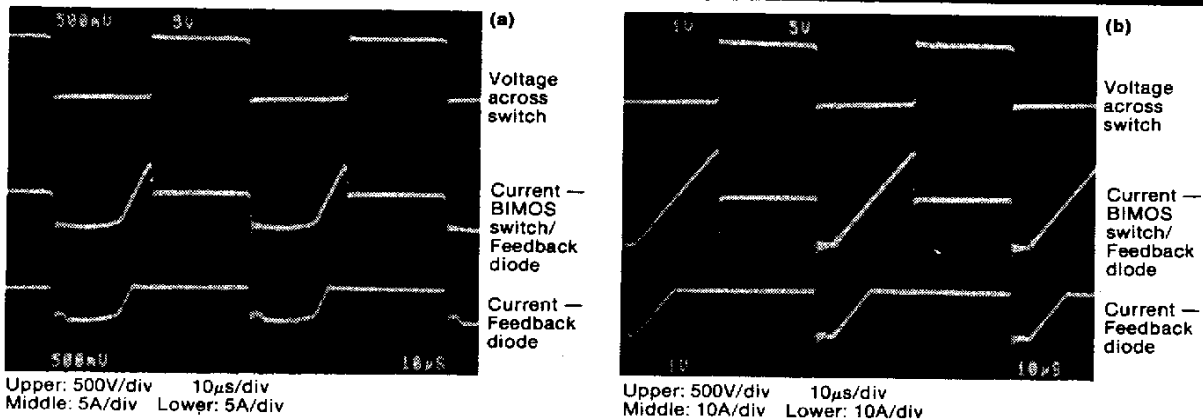

Figure 21. Voltage and current waveforms for BIMOS switch and feedback diode (No. 1) 650V DC input. (a) "Partial" output voltage (b) "Full" output voltage

Figure 19 shows voltage and current waveforms for the BIMOS switch at partial output voltage, when turning off 3A. The storage time is approximately 600ns, and the sum of the voltage rise and current fall times is about 500ns.

Figure 20 shows similar waveforms at full output voltage, when turning off 10A. The storage time is about

500ns, and the sum of the voltage rise and current fall times is about 300ns.

Note that the current waveforms in Figures 19 and 20 include the current in the clamping circuit D3, C2, R3 (Figure 11). The current fall-times seen in these oscillograms are therefore *greater* than for the BIMOS switch itself.

Figure 21 shows waveforms of voltage and current for the No. 1 BIMOS switch/feedback diode combination, and the waveform of current for the feedback diode by itself. Note the "notch" of current "missing" from the feedback diode current waveform. The "missing" current flows through the base-collector junction of the bipolar transistor, as explained below.

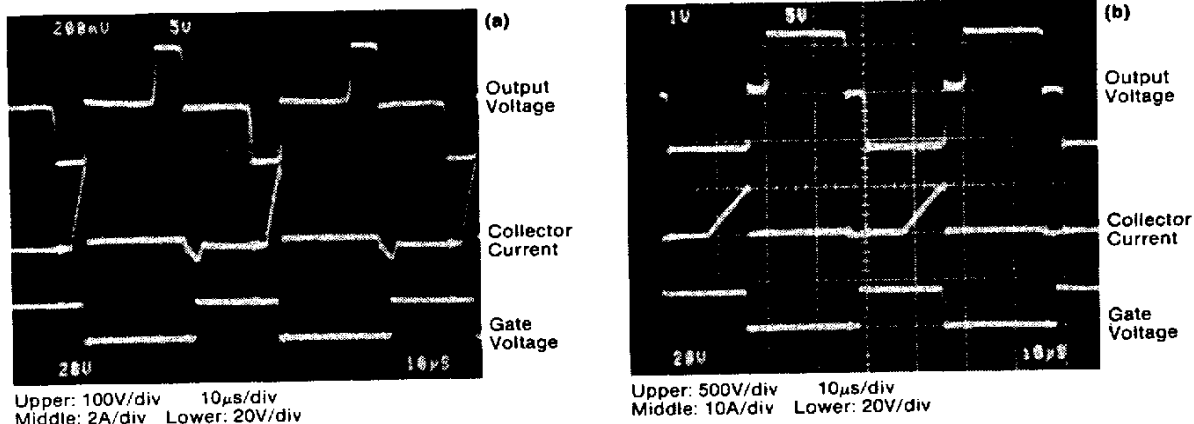

Upper: 100V/div 10 μ s/div
Middle: 2A/div Lower: 20V/div

Upper: 500V/div 10 μ s/div
Middle: 10A/div Lower: 20V/div

Figure 22. Output voltage, collector current, and gate voltage waveforms. (Switch No. 1) 650V DC input.
(a) "Partial" output voltage (3A peak) (b) "Full" output voltage (10A peak)

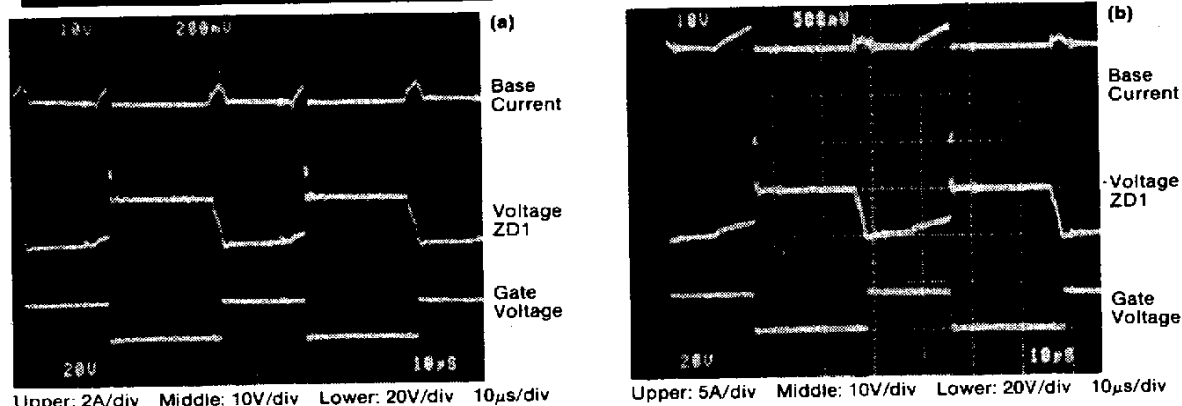

Upper: 2A/div Middle: 10V/div Lower: 20V/div 10 μ s/div

Upper: 5A/div Middle: 10V/div Lower: 20V/div 10 μ s/div

Figure 23. Base current, zener voltage, and gate voltage waveforms for BIMOS switch. 650V DC input.
(a) "Partial" output voltage (b) "Full" output voltage

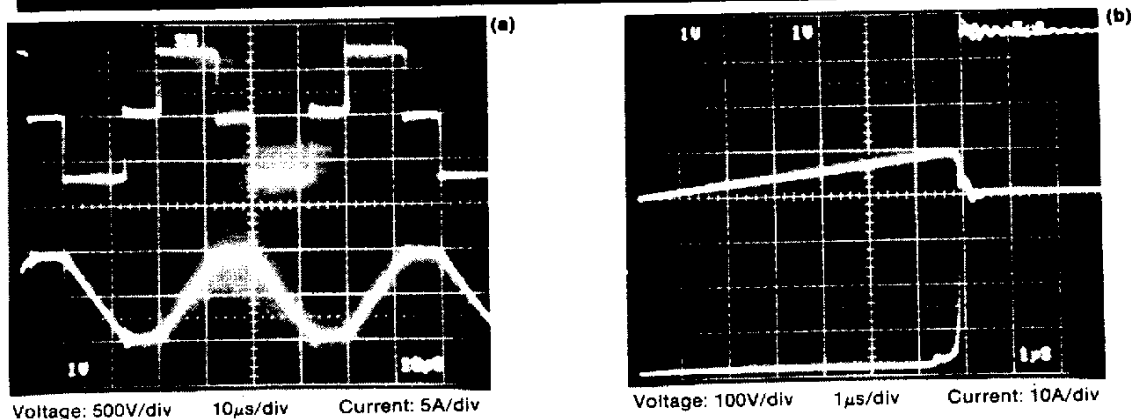

Voltage: 500V/div 10 μ s/div Current: 5A/div

Voltage: 100V/div 1 μ s/div Current: 10A/div

Figure 24. Waveforms of (a) Output voltage and current and (b) Switch voltage and current at turn-off. 750V DC input

Figure 22 shows waveforms of output voltage, collector current, and gate voltage for BIMOS switch No. 1. Note the negative collector current notches — the "missing" feedback diode current notches referred to above — which occur just after the opposite device in the same inverter leg has turned OFF, but before the No. 1 HEXFET is gated ON. During

this period, the inductive load current flows through the bipolar transistor's collector base junction, which is forward biased by the voltage on the capacitor C1. By the time the HEXFET is gated ON, whatever charge still remains on capacitor C1 is rapidly discharged through the HEXFET, and the load current transfers into the feedback diode (D4).

Figure 23 shows waveforms of base current, zener voltage, and gate voltage for BIMOS switch No. 1. The "notch" of base-collector current referred to above can be seen on the base current waveform. This notch of current substantially discharges capacitor C1 by the time the HEXFET is gated ON.

Figure 24 shows waveforms of out-

Table 4. Comparisons Between Alternative Devices

	BIMOS SWITCH	HIGH VOLTAGE HEXFET	GTO
Maximum voltage capability	1000V	1000V	1800V
Switching speed	Fast 40ns to 250ns fall time 180ns to 1 μ s storage	Very Fast 50 to 100ns fall time No storage	Moderate 1 to 2 μ s fall time 1 μ s storage
Voltage drop	Moderate	High	Low
Snubber energy	Low	Low	High
Relative efficiency	Good at intermediate to high frequency	Good at high frequency. Moderate at low frequency.	Good at low frequency. Poor at high frequency.
Overload capability	Poor	Good	Good
Drive Circuitry	Simple	Simple	Complex

Table 5. Approximate Cost Comparison

	850V 10A BIMOS		850V 10A HEXFET	850-1500V 10A GTO
Basic Device Cost	2N6547	\$2.90	\$7.00*	\$4.00*
	IRFZ24*	\$0.60		
Other circuit components	3.60		0.50	0.70
Drive circuitry (isolated)	0.50		0.50	3.00
Total \$	\$7.60		\$8.00	7.70

* Estimated 10K piece price, 1991

put voltage, output current, and voltage and current for the No. 1 BIMOS switch at turn-OFF, with a DC input voltage of 750V. The peak load current is about 10A. These waveforms are included to demonstrate the solid capability of the BIMOS switch to operate at a voltage close to the V_{CBO} rating of the bipolar — and actually represent a slight excursion beyond the limits of the common base Safe Operating Area shown in Figure 3 for the 2N6547.

Comparison With Alternatives

Alternative candidate devices to the BIMOS switch are (a) a single high voltage HEXFET (or two HEXFETs connected in series, which would have approximately similar characteristics) and (b) a gate turn-off thyristor (GTO).

Each of the three alternatives has its own particular features, and each will find use in the applications in which it best fits. A comparison between the most salient features of a BIMOS switch, a high voltage HEXFET, and a GTO is given in Table 4. Table 5 gives an approximate comparison of component costs; this provides an indication of relative costs, and is not exact. It does not include circuit assembly costs, which will have a modifying effect, but will not greatly alter the relative comparison.

The following general summary can be made:

- A high voltage HEXFET (or two HEXFETs connected in series) offers the fastest switching speed, and therefore has the greatest advantage at high frequency (say 200kHz and above). For lower frequency it will generally not be the best choice for applications requiring 850-1000V rating, because voltage drop and cost are relatively high.
- The GTO offers the highest voltage capability — up to 1800V — and will generally be the best choice for applications that require device voltage ratings substantially in excess of 1000V, provided that the operating frequency is not too high — say 10 to 15kHz maximum. (It is to be noted, however, that the GTO *can* be operated at higher frequency, perhaps up to 50kHz, by operating at reduced current and/or voltage. But cost per switching volt-ampere then increases significantly.) Switching speed of the GTO at normal "rated" conditions is relatively slow, and snubber energy is relatively high. Snubber losses per device could typically be 50W for a GTO switching 10A at 700V, at 10kHz — unless a complex "loss-less" snubber circuit is used. Drive

circuitry for the GTO is also relatively complex.

- The BIMOS switch offers higher frequency than the GTO, up 100 or 200kHz, with relatively good efficiency. Its cost is significantly lower than for a high voltage HEXFET, but higher than for a GTO. Several discrete components are needed to make a BIMOS switch, which is a disadvantage, but external drive circuitry is simple.

Another possibility, not included in the above comparison, would be a cascode connection of GTO and low voltage HEXFET. This would offer higher voltage capability than the BIMOS switch, but would have slower switching speed, higher losses, and probably somewhat higher cost. It would have the advantage over the GTO on its own of much simpler external drive circuitry, and improved switching speed.

Conclusion

The BIMOS switch should be considered as a serious candidate for applications requiring device voltage ratings up to 1000V, operating frequency up to one or two hundred kilohertz, and power levels up to tens of kilowatts. □